



IP44

220-240 V 50/60 Hz



Lisez attentivement les instructions avant l'installation.

L'installation doit être réalisée par un professionnel qualifié conformément aux règles d'installation en vigueur (NF C 15-100 en France).

Débranchez l'alimentation électrique avant l'installation ou la maintenance.

Vérifiez que la tension du réseau correspond aux caractéristiques du luminaire.

Assurez-vous que les fils ont été correctement connectés avant de mettre l'appareil sous tension.

Assurez-vous que le produit dispose d'un espace suffisant pour la dissipation de la chaleur. Coupez l'alimentation électrique avant toute installation ou entretien.

Ne pas utiliser si le luminaire, le câble ou le diffuseur sont endommagés.

Température d'utilisation -25°C / + 40°C

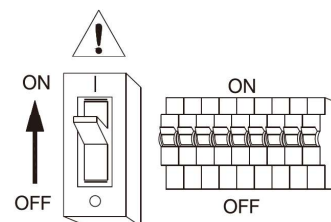
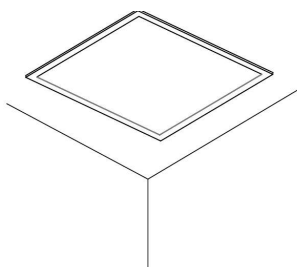
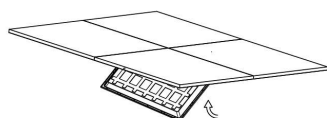
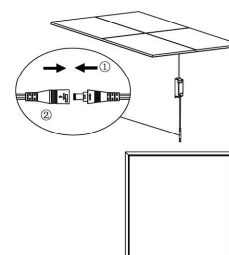
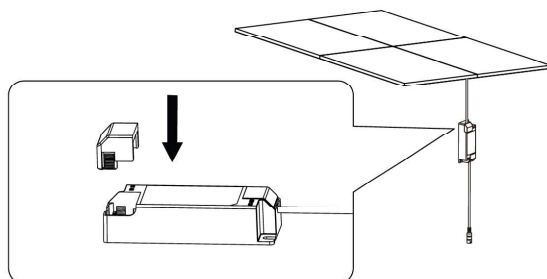
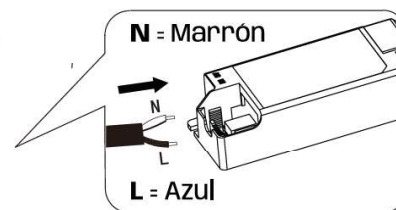
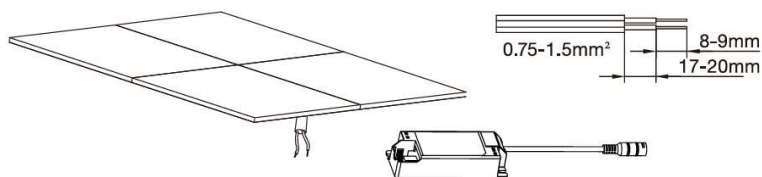
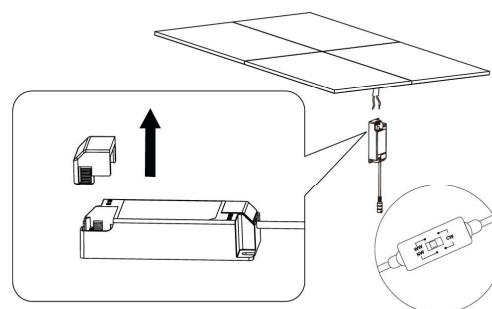
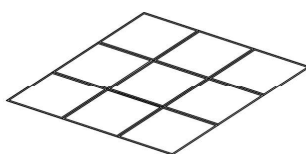
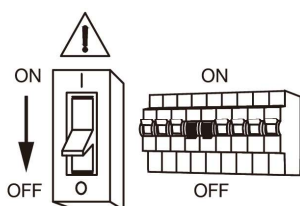

### Raccordement électrique:

